

Right Angles in 2D Shapes

Purple Parrots

I can find right angles in a wide range of polygons.

Can you find any right angles inside these shapes? Draw a square to show where you find a right angle. One has been done for you.

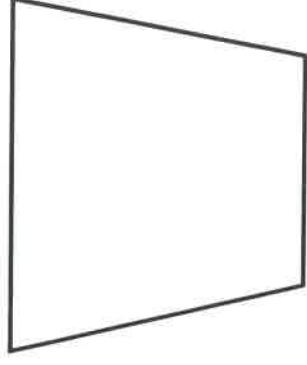
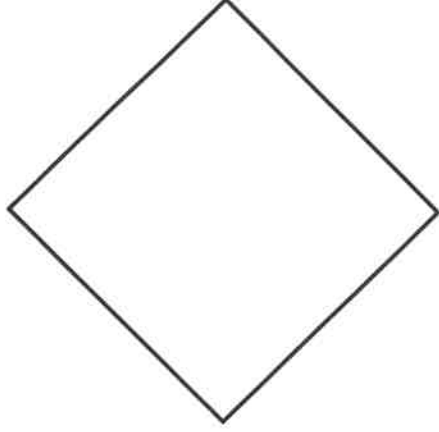
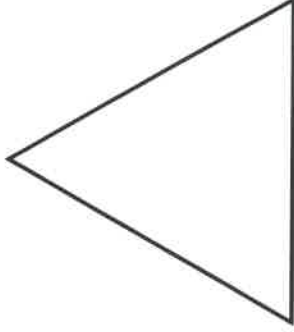
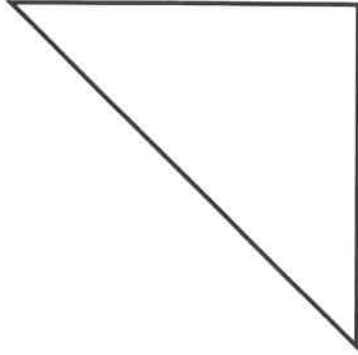
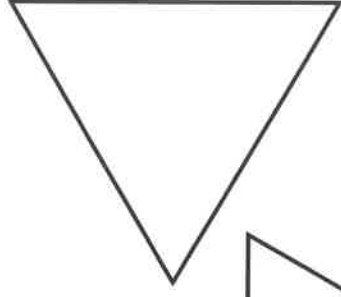
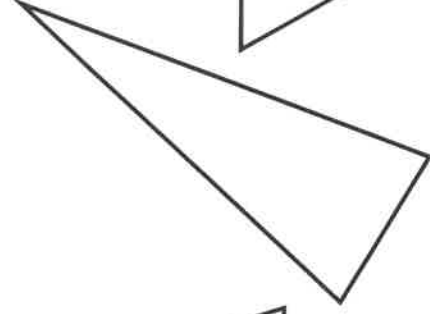
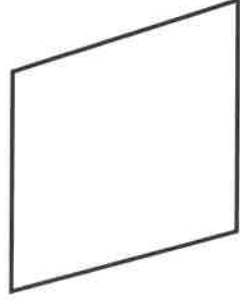
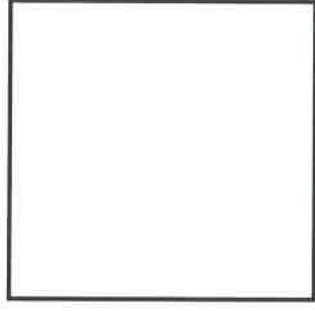
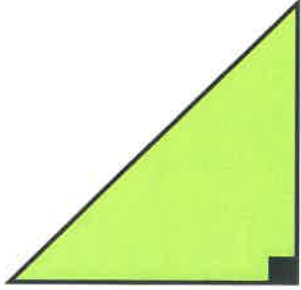



Right Angle Investigation

I can identify right angles.



Look at the quadrilaterals and then complete the true or false table.

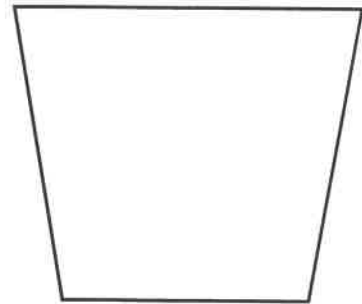
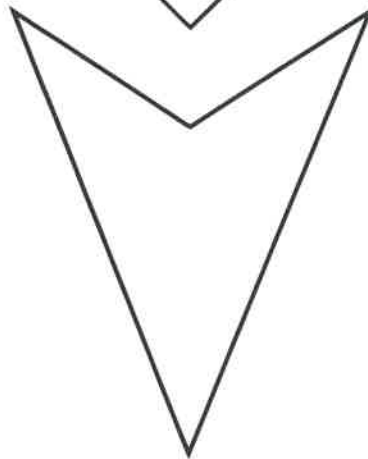
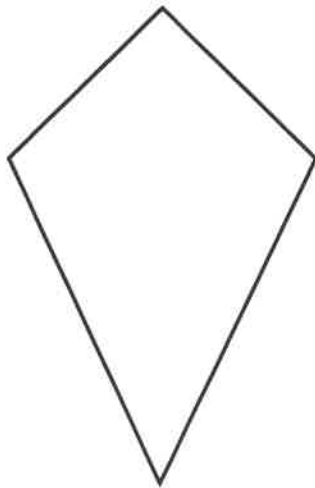
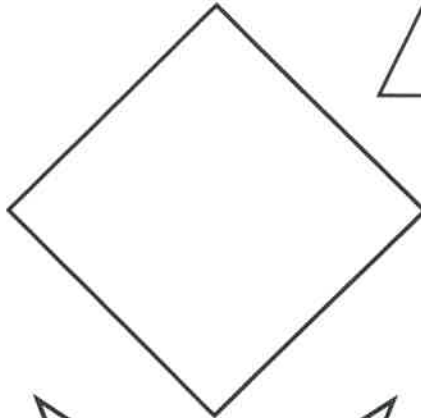
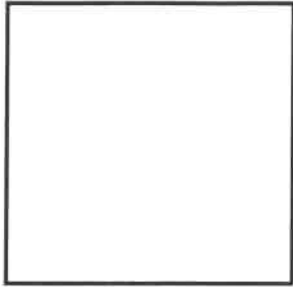

Statement	True	False
All quadrilaterals have 4 right angles.		
All quadrilaterals have at least one right angle.		
All irregular quadrilaterals have no right angles.		



Right Angles Colouring

I can identify right angles.



Colour in the angles you can find:
red for right angles, green for acute angles and blue for obtuse angles.

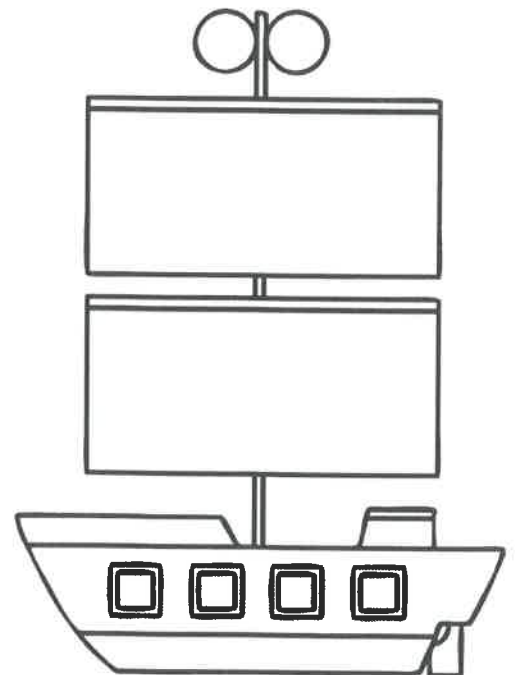
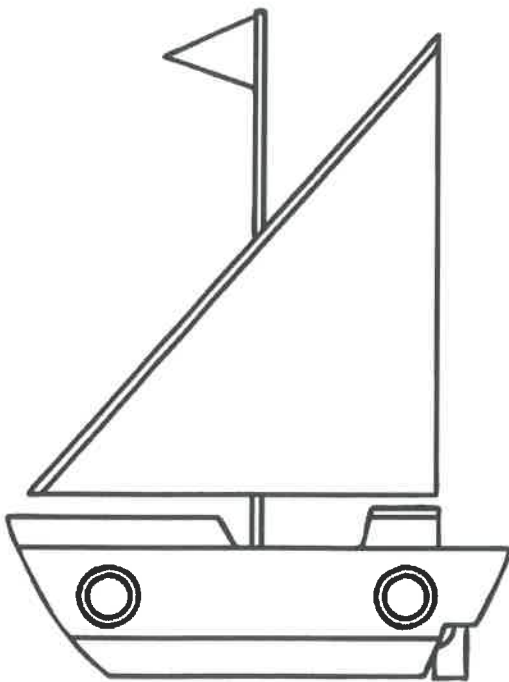
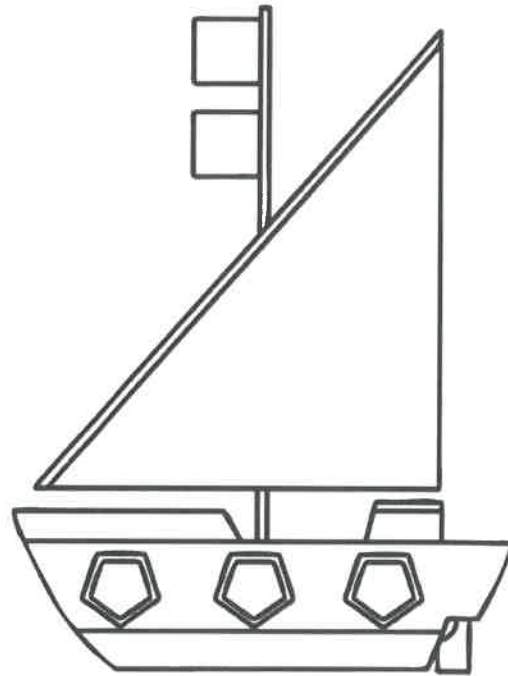

Brown Bears.

★ Right Angles in the Home

I can identify right angles.



Find 9 examples of right angles in your home and draw them in the boxes below.
